

USER MANUAL MEAX Coaxiality



CONTENT

Welcome to Our World	1.1
Declaration of Conformity	2.1
Safety	3.1
Care	4.1
Sensors MEAX SM 201 and SR 201	5.1
MEAX Coax App	6.1
Technical Specification MEAX SM 201 and SR 201	7.1

WELCOME TO OUR WORLD

Since the very beginning in 1984, ACOEM AB has helped industries throughout the world to achieve more profitable and sustainable production. We have reached where we are today by having the courage to think beyond the norm and follow slightly unconventional paths. We have had the courage to make mistakes and find new directions. Through our resolve, ambition and knowledge we have become a global player and a leader in innovative, user-friendly measurement tools.

MEAX

As ever-increasing demands are being placed on machine tools, we have arrived at the conclusion that an optimally functional machine forms the basis for better business. Modern machine tools must maintain a high level of flexibility, a high degree of utilization and a minimum downtime which calls for the correct geometry in all the machine's movements.

So we created MEAX and started to sketch solutions for machine tool measurements that, in our opinion, are so self-evident that they should have been developed a long time ago.

By performing fast measurements, possessing a logical user interface, smart applications and fewer complicated functions, we can now build a future for machine tool measurement.

END USER LICENSE AGREEMENT

The rights to use the software in this product are offered only on the conditions that you agree to all the terms stated below, i.e. the end user agreement. By using this product you agree to be bound by this agreement. If you do not accept this agreement your sole remedy is to return the entire unused product, hardware and software, promptly to your place of purchase for a refund.

The user is granted a single license to use the software contained in this product. Use is only permitted on the hardware it has been installed on at the time of purchase. The software may not be removed from the hardware.

The software contained in the system is the property of ACOEM AB, any copying or redistribution is strictly prohibited.

Modifying, disassembling, reverse engineering or decompiling the system or any part thereof is strictly prohibited.

Disclaimer of warranties: To the maximum extent permitted by applicable law, ACOEM AB and its suppliers provide the software contained in this product 'as is' and with all faults, and hereby disclaim all other warranties either expressed, implied or statutory.

Limited liability: No liability shall exceed the price of the product, and the sole remedy, if any, to any claim shall be a right of return and refund.

ACOEM AB or its suppliers shall, to the maximum extent permitted by applicable law, not be liable to any indirect, special, incidental, punitive, and consequential damages arising from the use of the system or any part thereof, authorized or unauthorized.

ACOEM AB (formerly known as Elos Fixturlaser AB) is since mid-2014 a fully owned subsidiary of ACOEM Group, headquartered in Lyon, France. Other brands within ACOEM Group are 01dB, ONEPROD, METRAVIB and FIXTURLASER. For more information please visit www.acoemgroup.com

DECLARATION OF CONFORMITY

In accordance with the EMC Directive 2004/108/EC, the Low Voltage Directive 2006/95/EC, including amendments by the CE-marking Directive 93/68/EEC & EC directives RoHS 2011/65/EU.

Type of equipment

Coaxiality System

Brand name or trade mark

MEAX Instruments

Type designation(s)/Model no(s)

1-0986 MEAX SM 201

1-0987 MEAX SR 201

Manufacturer's name, address & phone no

ACOEM AB
Box 7
SE-431 21 Mölndal
Sweden

Phone: +46 31 7062800

The following standards and/or technical specifications, which comply with good engineering practice in safety matters in force within the EEA, have been applied:

Standard/Test report/Technical construction file/Normative document

EN 61000-6-3:2007.

EN 61000-6-2:2005, EN 61000-4-2, -3, -4, -5, -6, -11.

EN 61010-1:2010

ISO9001:2008 Ref. No/ Issued by: DNV Certification AB Certification No. 2009-SKM-AQ-2704/2009-SKM-AE-1419.

The wireless device complies with Part 15 of the FCC Rules. Operation is subject to the following two conditions;

- (1) this device may not cause harmful interference, and
- (2) this device must accept any interference received, including interference that may cause undesired operation.

Additional information

The product was CE-marked in 2015.

As manufacturer, we declare under our sole responsibility that the equipment follows the provisions of the Directives stated above.

Date and place of issue

Möln dal 2015-10-15

Signature of authorized person

A handwritten signature in black ink, appearing to read 'Hans Svensson', written in a cursive style.

Hans Svensson, Managing Director

SAFETY

Retain and follow all product safety and operating instructions. Observe all warnings on the product and in the operating instructions.

Failure to observe the safety pre-cautions and operating instructions can cause bodily injury, fire, and damage to the equipment.

Do not disassemble, modify or use the equipment in other ways than explained in the operating instructions. ACOEM AB will not accept any liability for such use.



WARNING!

Make sure to fully comply with all appropriate safety measures and regulations at worksite and local regulations regarding safety in a machine environment. Do not operate a machine such as a lathe, if you have not received safety instructions and understand how to use the machine. Take all appropriate measures to prevent unintentional start-up of machines.

LASER PRECAUTIONS

MEAX Instruments uses laser diodes with a power output of < 1.0 mW. The laser classification is Class 2.

Class 2 is considered safe for its intended use with only minor precautions required. These are:

- Never stare directly into the laser transmitter.
- Never shine the laser directly into anyone else's eyes.



COMPLIES WITH 21 CFR 1040.10 AND 1040.11
EXCEPT FOR DEVIATIONS PURSUANT TO
LASER NOTICE No. 50, DATED JUNE 24, 2007



CAUTION!

USE OF CONTROLS OR ADJUSTMENTS OR PROCEDURES OTHER THAN THOSE SPECIFIED HEREIN MAY RESULT IN HAZARDOUS RADIATION EXPOSURE.

Your system complies with the requirements in:

- IEC-60825-1:2007
- British Standard BS EN 60825-1
- DIN EN 60825-1

USA FDA Standard 21 CFR, Ch 1, Part 1040.10 and 1040.11

POWER SUPPLY

The MEAX equipment is powered by a high-capacity rechargeable Li-Ion pack mounted in the sensor.

When used in typical conditions the battery will sustain good capacity for approximately 2-3 years before needing replacement. Contact your sales representative for battery replacement.

The batteries contain safety circuitry to operate safely with the sensor. The sensor can therefore only be used with the Li-Ion batteries supplied by MEAX.

Improper replacement of batteries can cause damage and risk for personal injury.



WARNING!

BATTERY REPLACEMENT SHALL ONLY BE PERFORMED BY AUTHORIZED MEAX REPRESENTATIVES.

USE OF ANY OTHER BATTERIES THAN THOSE SUPPLIED BY MEAX WILL CAUSE SEVERE DAMAGE TO THE SENSOR AND CAN CAUSE RISK FOR PERSONAL INJURY!

Handle any batteries with care. Batteries pose a burn hazard if handled improperly. Do not disassemble and keep away from heat sources. Handle damaged or leaking batteries with extreme care. Please keep in mind that batteries can harm the environment. Dispose of batteries in accordance with local regulatory guidelines, if in doubt contact your local sales representative.

Only use 5V USB charger or battery life extender to charge the battery. Using other power adapters can cause damage to the unit and personal injury.

WIRELESS TRANSCEIVER

The MEAX system is fitted with a Bluetooth wireless transceiver.

Make sure that there are no restrictions on the use of radio transceivers at the site of operation before using the wireless transceivers.



WARNING!

Before using the wireless transceivers make sure that there are no restrictions on the use of radio transceivers at the site. Do not use on aircraft.

CARE

CASE

Make sure to use the supplied case when transporting the sensor units.



CLEANING

The sensors should be cleaned with a cotton cloth or a cotton bud moistened with a mild soap solution, with the exception of the detector and laser window surfaces, which should be cleaned with alcohol.

For the best possible function, the laser diode apertures, detector surfaces and connector terminals should be kept free from grease or dirt.

Do not use paper tissue, which can scratch the detector surface.



Do not use acetone.

SENSORS MEAX SM 201 AND SR 201

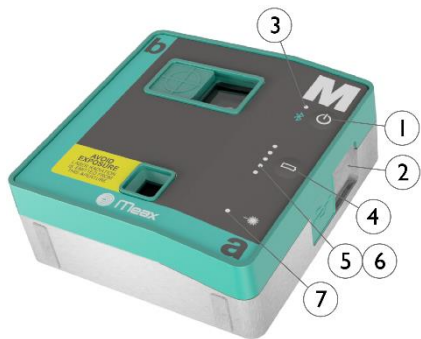

1. ON/OFF button with status indication LED
 - a. Continuously green – On

2. Mini USB for charging
3. Bluetooth indication LED
 - a. Continuously blue – paired and ready.
 - b. Flashing blue – searching/ready to pair
 - c. No light – Bluetooth disabled.
4. Battery status button – press to instantly show the battery status (also works when the unit is switched off).
5. Battery status LED
 - a. One LED flashing red – less than 10% charge left.
 - b. One LED double flashing red – less than 5% charge left.

- c. One LED continuously orange – charging
 - d. One LED continuously green – fully charged
6. Battery status LED when battery button is pressed
- a. Continuously green – battery status
 - b. Rolling green – battery charging
7. Laser status LED
8. Laser button (SR 201 only)
9. Hole pattern for spindle holder
10. Horizontal reference surfaces

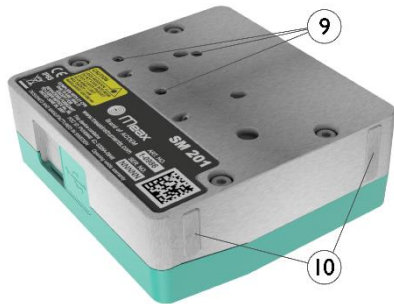

OPERATING MODES

MEAX SM 201 and SR 201 units has two operating modes: On and Off.

Turn the units on and off by pressing the ON/OFF button firmly.

In case the units fail to respond, it is possible to turn it off by pressing down the ON button for more than 10 seconds.

CONNECTIONS

Bluetooth connection

The main connection for SM 201 and SR 201 units is the built in Bluetooth connection.

See Bluetooth settings in the chapter “MEAX Coax App” for instructions on how to pair measurement units with the app.

POWER SUPPLY

The SM 201 and SR 201 units are powered by a high-capacity rechargeable Li-Ion cell, or by the external power unit.

The operating time of the batteries is approximately 10 hours when the system is used for a typical measurement work (continuously on).

The SM 201 and SR 201 units can be charged with the supplied combined charger or any 5V USB charger or battery life extender.

When the external power supply is connected, the unit will automatically start charging the batteries. This will be indicated by the first battery status LED turning orange, when the unit is fully charged the LED will turn green. By pressing the battery status button the exact charging status can be monitored.

The charging time is approximately 8 hours for fully drained batteries. (Charging to 50%

takes approximately 2 hours.) The charging time will be longer if the unit is turned on while being charged.

When used in typical conditions the batteries will sustain good capacity for approximately 2-3 years before needing replacement. Contact your sales representative for battery replacement.

The batteries contain safety circuitry to operate safely with the unit. The unit can therefore only be used with the Li-Ion batteries supplied by MEAX. Improper replacement of batteries can cause damage and risk for personal injury. Please refer to the chapter on safety for further instructions.

MEAX COAX APP

INTRODUCTION

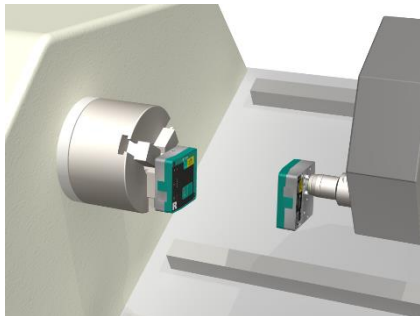

Download the MEAX Coax app from Google Play or App Store.



Visit the website www.meax.com for more information.

MEAX Coax is a companion app for performing high precision coaxiality measurements of machine tools, typically between two opposing workhead spindles or a workhead spindle and a tool holder.

The app guides the user through the complete measurement and evaluation process when using the high precision MEAX transmitter/detector sensors SM 201 and SR 201. Together, this simplifies the otherwise cumbersome and time consuming task to ensure that workhead spindle and tools are perfectly aligned, or to quickly check that a machine is still within tolerance after a crash.

The MEAX Coax app works with the measurement units MEAX SM 201 and MEAX SR 201.

STARTING THE APP

Before mounting, start the app on the tablet and turn on the sensors.



Starting MEAX Coax App.

Pair the sensors for connection to the tablet.*

Set tolerance.*

*) See Settings in the end of this chapter.

CONFIGURATION

Machine bed slant

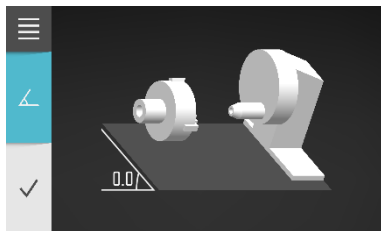

The machine bed slant is measured with the SM sensor.

If you have an existent machine bed slant, you just need to confirm it.



Settings.



Measure machine bed slant with the SM sensor.



Confirm existent machine bed slant.

When measuring machine bed slant with the SM sensor, the angle value is displayed live.

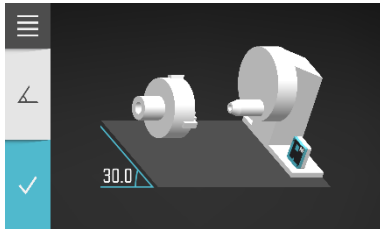

Place the SM sensor at the machine bed slant.

Measure and confirm machine bed slant.



Confirm measured machine bed slant.

Mounting

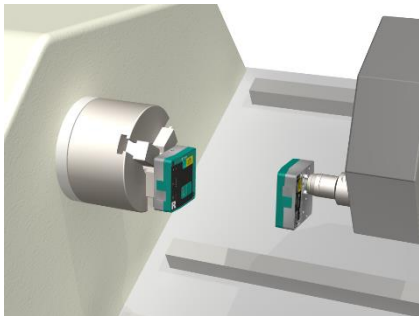

Mounting of the sensors are made by shafts $\varnothing 16$, fitting made for hydraulic chucks. In the spindle you must use a protective collet if the jaws are hardened.

You can either use the supplied protective collets with outer diameter of 20 mm, or you can use your own collets.

Mount the sensors, SR in the main workhead spindle.

(SR will represent the reference.)

Mount SM in the tool holder or in the opposite workhead spindle. (SM will represent the measured value.)

If the spindles have numerical control functions you can use that to achieve the positions the software are asking for. If not, you have to turn them manually. You can set the hydraulic pressure in the chuck on a level which gives the SM sensor stability but you can still rotate it between the measurement positions.

Distances

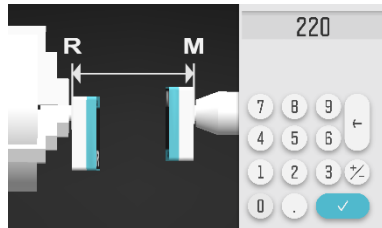

Measure and enter distance between the sensors SR and SM.

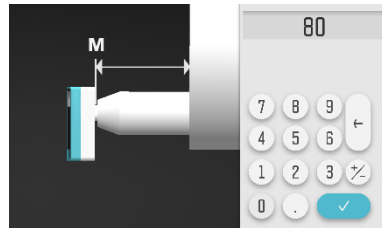

Measure and enter distance from the sensor SM to the Tool.

This gives the offset position.

MEASUREMENT

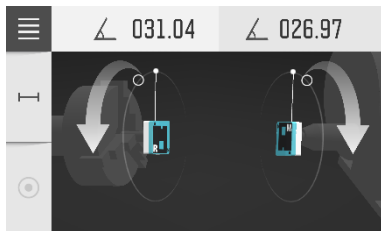

The screen displays the main spindle with the SR sensor to the left and the tool holder with the SM sensor to the right.

The rotational angles for each sensor are displayed at the top. These angles are relative to the machine bed slant.

The measurement is carried out by register values in four positions, 0°, 90°, 180° and 270°. The small circles show where to rotate the sensors. Both the sensors must be inside 0.1° at each position.

Set the sensors at the first measurement position, at the rotational angle 0°.

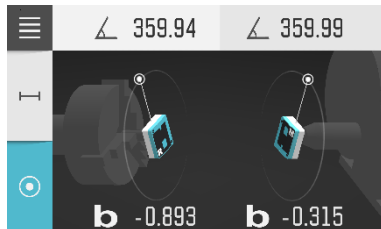

Touch the measurement icon.



This registers the first measurement position.



Rotate the sensors to the second measurement position, at the rotational angle 90° .



Touch the measurement icon.

This registers the second measurement position.

Rotate the sensors to the third measurement position, at the rotational angle 180° .

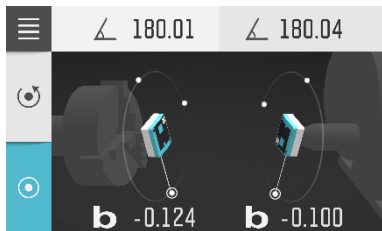

Touch the measurement icon.

This registers the third measurement position.



Touch the measurement icon.

This registers the fourth measurement position.

Rotate the sensors to the fourth measurement position, at the rotational angle 270° .

MEASUREMENT RESULT

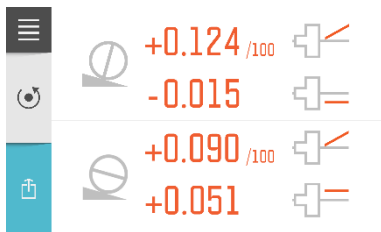

The measurement result screen displays angle and offset values in two directions, perpendicular to the machine bed slant and parallel to the machine bed slant.

The symbols and the colour of the values show if the values are inside the selected tolerance or not.



Perpendicular direction in tolerance.



Perpendicular direction out of tolerance.



Parallel direction in tolerance.



Parallel direction out of tolerance.



Angle in tolerance.



Angle out of tolerance.



Offset in tolerance.



Offset out of tolerance.



Re-measure.



Share (Android)

Result screen is shared.



Share (iOS)

Result screen is shared.



Measurement result in tolerance.

SETTINGS

Bluetooth settings

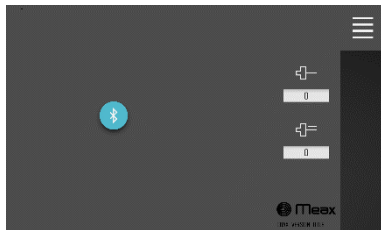

Touch the search icon to search for units that are pair able.



Search for Bluetooth units.

Pair able units will appear in the list.

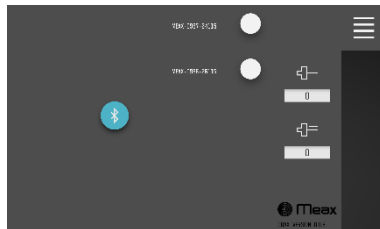

Touch the white icon beside the units to pair.

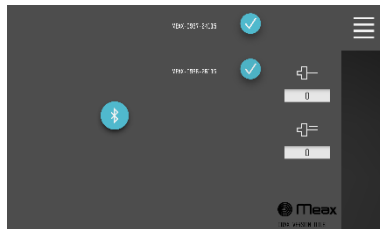

Paired units are marked with a check mark.

To unpair units, touch the check mark icon beside the units to unpair.

Tolerance

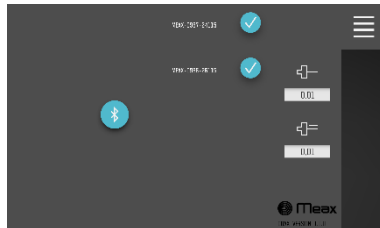

Touch the tolerance values to change them.

TECHNICAL SPECIFICATION – MEAX SM 201 AND SR 201

Part No SM 201: 1-0984, SR 201: 1-0985

Housing material	Anodized Aluminum and ABS plastic
Operating temp	15 to 30°C (59 to 86°F)
Storage temp	-20 to 70°C (-4 to 158°F)
Battery charging temp	0 to 40°C (32 to 104°F)
Relative humidity	10 – 90%
Weight	306 g (10.9 oz)
Dimensions	82 mm x 86 mm x 33 mm (3.2 in x 3.4 in x 1.3 in)
Environmental protection	IP 65 (Dust tight and protected against water jets)
Laser	650 nm class II diode laser
Laser power	< 1 mW
Measurement distance	Up to 3 m
Detector	2-axis PSD
Detector size	16 mm x 16 mm (0.6 in x 0.6 in)
Detector resolution	1 μ m
Measurement accuracy	1% \pm 3 μ m

Ambient light protection	Optical filtering and ambient light signal rejection
Inclinometer resolution	0.01°
Inclinometer accuracy	±0.1°
Warming up time	30 min
Wireless communication	Class I Bluetooth transceiver with multi-drop capability. BLE Bluetooth Low Energy (BT 4.0) and Classic Bluetooth.
Communication range	10 m (33 ft)
Peripherals – User accessible	1 USB Mini port; Charging: 5V, 0,5A
Power supply	High performance Li Ion battery or external power.
Operating time	10 hours continuously
Battery charging time (system off, room temp)	8 h
Battery capacity	10.4 Wh
LED indicators	Unit state, laser transmission, battery status and Bluetooth status

Specifications are subject to change without notice.



Publication No. P-0275-GB

© 2015 ACOEM AB, Mölndal, Sweden

All rights reserved. No part of this manual may be copied or reproduced in any form or by any means without prior permission from ACOEM AB

www.meax.com